

**GUARANTEED PRE-ORDER DUE DATE: WEDNESDAY JUNE 7<sup>TH</sup>, 2023**

**CONSUMER EDITION**



# 'PREMIER' CATALOG

## SPRING 2023

Atlas O Premier  
SD70MAC  
Locomotives  
Pages 4-7



# LOCOMOTIVES, ROLLING STOCK TRACK & ACCESSORIES



## PREMIER CATALOG - SPRING 2023



**GUARANTEED PRE-ORDER DUE DATE:  
WEDNESDAY JUNE 7<sup>TH</sup> 2023**

April 2023

Dear O Scale Model Railroader,

Welcome to the Spring 2023 Atlas O Premier Catalog. Catalogs such as this one are the basis of Atlas' distinctive "guaranteed" pre-order system. Before the Research & Development department gives the final go ahead for production, Atlas announces to its customers the products we are preparing to make. This announcement comes in the form of our Atlas Model (HO & N) and Atlas O Premier Catalogs that provide our customers with the opportunity to arrange a guaranteed pre-order if placed by the given deadline. If possible, Atlas will try to fill orders placed after a given deadline, but these cannot be guaranteed. Occasionally, we offer 'Limited Availability' products for which we have speculated on order quantities and therefore these orders cannot be guaranteed. Either way, its best to place orders as soon as possible for your best chances at acquiring a selected product.

This catalog includes opportunities to reserve select Guaranteed Pre-Order Premier Locomotives as well as Master & Premier rolling stock. Atlas O continues the expansion of the O locomotive line with offerings of the Premier SD-70MAC, as well as Premier E8 Locomotives with matching Streamlined Passenger Cars. All of these locomotive offerings will come equipped with MTH DCS, Proto-Sound 3.0!

This catalog also includes the release of several rolling stock models in the Master and Premier lines including: Rapid Discharge Hoppers, 3 & 6 Bay Cylindrical Hoppers, 17,600 Gallon Corn Syrup Tank Cars and more - with authentic prototypical paint schemes. We're also announcing new runs of 40' Stock Cars and 50'6" Box Cars in our Trainman line. Throughout the catalog, you'll notice Atlas Collectors' Series Limited Edition paint scheme offerings. These items will only be produced one time, so seize the opportunity to add these to your freight car roster while you can! Rounding out the announcements are new Sanding Towers featuring colorful railroad logos - a great trackside addition to your model railroad empire.

Last, but not least, this announcement brochure serves as a reminder to all our customers, of the extensive line of Atlas O track, accessories, trackside buildings, signal system and other structures that Atlas O has available on a day to day basis. Whether you're rehabilitating an existing layout, or building one from scratch, Atlas O customer service and sales representatives are ready to assist you in whatever way we can to make your layout a reality.

To remain updated on all Atlas O products and special announcements, sign up for the Atlas Insider Email at <https://shop.atlasrr.com>.

Happy Model Railroading,  
Drew Postle, Atlas Sales Manager

---

Products bearing American Refrigerator Transit; Chicago & Eastern Illinois (C&EI); Chicago and North Western Railway Company (CNW); The Denver & Rio Grande Western Railroad Company (D&RGW); Katy; Missouri-Kansas-Texas Railroad Company (MKT); Missouri Pacific (MP); Pacific Fruit Express (PFE); Southern Pacific (SP); St. Louis Southwestern Railway Company (SSW); Cotton Belt; Texas & Pacific (T&P); Union Pacific (UP); Union Pacific Fruit Express (UPFE); Western Pacific (WP) marks are made under trademark license from Union Pacific Railroad Company.

---

Atlas Model Railroad Co., Inc. • 378 Florence Ave., Hillside, NJ 07205 • USA • ph: 908-687-0880 • fax: 908-687-8857 / 908-851-2550 • [shop.atlasrr.com](https://shop.atlasrr.com)



# TABLE OF CONTENTS

**PRE-ORDER ANNOUNCEMENTS** **PAGE #**

**O SCALE** **ATLAS O PREMIER CATALOG ANNOUNCEMENTS  
LOCOMOTIVES, PASSENGER CARS & ROLLING STOCK**

ATLAS O PREMIER SD70MAC LOCOMOTIVE **NEW ATLAS O MODEL**..... pgs.4-7

ATLAS O PREMIER E8 LOCOMOTIVE **NEW ATLAS O MODEL**..... pgs.8-11

ATLAS O PREMIER STREAMLINED PASSENGER CAR **NEW ATLAS O MODEL**..... pgs.12-17

ATLAS O PREMIER RAPID DISCHARGE HOPPER **NEW ATLAS O MODEL**..... pgs.18-19

ATLAS O PREMIER 2-BAY OFFSET HOPPER **NEW PAINT SCHEMES** ..... pgs.20-21

ATLAS MASTER® O ACF® 3 & 6 BAY CYLINDRICAL HOPPER **NEW PAINT SCHEMES**..... pgs.22-23

ATLAS MASTER® O TRINITY 17,600 GALLON CORN SYRUP TANK CAR **NEW PAINT SCHEMES & NEW ROAD NUMBERS**..... pgs.24-25

ATLAS MASTER® O BERWICK 60' HY-CUBE BOX CAR **NEW PAINT SCHEMES & NEW ROAD NUMBERS**..... pgs.26-27

ATLAS TRAINMAN® O 40' STOCK CAR **NEW PAINT SCHEMES & NEW ROAD NUMBERS**..... pgs.28-29

ATLAS TRAINMAN® O 50'6" BOX CAR **NEW PAINT SCHEMES & NEW ROAD NUMBERS**..... pgs.30-31

**ATLAS O TRACK & ACCESSORIES**

ATLAS O SANDING TOWER WITH RAILROAD LOGOS **NEW ATLAS O ACCESSORY**..... pgs.32-33

ATLAS O TURNTABLE ..... pgs.34

ATLAS O SIGNAL SYSTEM ..... pgs.35

ATLAS O TRACK, STRUCTURES, ACCESSORIES & TRACK CATALOG ..... pgs.36-39

## To Order, Please Contact Your Authorized Atlas Dealer

*All prices are in US dollars. Prices and dates are subject to change without notice. Atlas reserves the right to correct errors, change prices and modify designs without notice. Any product pricing errors and updates may be corrected at any time through notification of distributors, dealers and consumers on our website: [shop.atlasrr.com](http://shop.atlasrr.com).*

© 2023 Atlas Model Railroad Co., Inc.



# PREMIER CATALOG SPRING 2023 - LOCOMOTIVES

**GUARANTEED PRE-ORDER DUE DATE:  
WEDNESDAY JUNE 7<sup>TH</sup> 2023**



## ATLAS O PREMIER SD70MAC LOCOMOTIVE

Product Info: <https://shop.atlasrr.com/d-693-spring-2023-o-scale-catalog.aspx>



**NEW  
ATLAS O  
MODEL**



BNSF (ex-BN excutive w/BNSF Wedge)



CSX\* (YN3 Website)



Lake State Railway



Metra

"Metra" and "Metra Metropolitan Rail" are registered servicemarks of Metra.

Atlas Model Railroad Co., Inc. • 378 Florence Ave., Hillside, NJ 07205 • USA • ph: 908-687-0880 • fax: 908-687-8857 / 908-851-2550 • [shop.atlasrr.com](http://shop.atlasrr.com)



# PREMIER CATALOG SPRING 2023 - LOCOMOTIVES

**GUARANTEED PRE-ORDER DUE DATE:  
WEDNESDAY JUNE 7<sup>TH</sup> 2023**



## ATLAS O PREMIER SD70MAC LOCOMOTIVE

Product Info: <https://shop.atlasrr.com/d-693-spring-2023-o-scale-catalog.aspx>



RJ Corman



Union Pacific (ONE)



Union Pacific (Big Boy Escort)



Paducah & Louisville



# PREMIER CATALOG SPRING 2023 - LOCOMOTIVES

**GUARANTEED PRE-ORDER DUE DATE:  
WEDNESDAY JUNE 7<sup>TH</sup> 2023**



## ATLAS O PREMIER SD70MAC LOCOMOTIVE

**Product Info:** <https://shop.atlasrr.com/d-693-spring-2023-o-scale-catalog.aspx>

**ESTIMATED ARRIVAL: 2nd Quarter 2024**

ORDER IN PIECES	3-RAIL ITEM	ROAD NAME	ROAD NUMBER	COLORS	MSRP / UNIT
	30138201	BNSF (ex-BN excutive w/BNSF Wedge)	9624	Green/Tan	\$679.95
	30138202	BNSF (ex-BN excutive w/BNSF Wedge)	9687	Green/Tan	\$679.95
	30138204	CSX (YN3 Website)	4569	Blue/Yellow	\$679.95
	30138205	CSX (YN3 Website)	4571	Blue/Yellow	\$679.95
	30138206	Lake State Railway	6431	Blue/White	\$679.95
	30138207	Lake State Railway	6432	Blue/White	\$679.95
	30138208	Metra	502	Blue/Black/Orange	\$679.95
	30138209	Metra	503	Blue/Black/Orange	\$679.95
	30138210	RJ Corman	1973	Red/White/Black/Gray/Gold	\$679.95
	30138211	RJ Corman	2023	Red/White/Black/Gray/Gold	\$679.95
	30138212	Union Pacific (ONE)	1979	Gray/White/Red/Orange/Blue	\$679.95
	30138213	Union Pacific (Big Boy Escort)	4015	Yellow/Red/Gray	\$679.95
	30138245	Paducah & Louisville	4512	Green/White/Black	\$679.95
	30138246	Paducah & Louisville	4518	Green/White/Black	\$679.95
<b>TOTAL PIECES ORDERED</b>					

In 1992, GM's Electro-Motive Division (EMD) introduced the new SD70 Series of engines, which come in the standard direct-current (DC) and alternating-current (AC) models. One glance at the design of this engine reveals the enormous technological gains in railroading. The SD70 boasts a 32-bit 16MHz control microprocessor named the EM2000. This computer works with the Integrated Cab Electronics (ICE) system to collect, analyze, and display a range of accurate-to-the-second information, such as speed, amps, throttle position, air brake operation, and cab signals. All of this information is displayed on full-color liquid crystal displays that replace the gauges and indicators found on earlier diesels.

The 70 Series also employs the HTRC (high-traction three-axle radial) truck that reduces rolling resistance in curves and lateral loads and therefore reduces wear on wheels. EMD estimates this will increase wheel life by 20 percent. These innovations have led to brisk sales of both the SD70M (DC version) and SD70MAC (AC version).

"Metra" and "Metra Metropolitan Rail" are registered servicemarks of Metra.

\*\* Prices are subject to change due to board availability/cost.



# PREMIER CATALOG SPRING 2023 - LOCOMOTIVES

**GUARANTEED PRE-ORDER DUE DATE:  
WEDNESDAY JUNE 7<sup>TH</sup> 2023**



## ATLAS O PREMIER SD70MAC LOCOMOTIVE

**Product Info:** <https://shop.atlasrr.com/d-693-spring-2023-o-scale-catalog.aspx>

**ESTIMATED ARRIVAL: 2nd Quarter 2024**

ORDER IN PIECES	2-RAIL ITEM	ROAD NAME	ROAD NUMBER	COLORS	MSRP / UNIT
	30138214	BNSF (ex-BN excutive w/BNSF Wedge)	9624	Green/Tan	\$679.95
	30138215	BNSF (ex-BN excutive w/BNSF Wedge)	9687	Green/Tan	\$679.95
	30138217	CSX (YN3 Website)	4569	Blue/Yellow	\$679.95
	30138218	CSX (YN3 Website)	4571	Blue/Yellow	\$679.95
	30138219	Lake State Railway	6431	Blue/White	\$679.95
	30138220	Lake State Railway	6432	Blue/White	\$679.95
	30138221	Metra	502	Blue/Black/Orange	\$679.95
	30138222	Metra	503	Blue/Black/Orange	\$679.95
	30138223	RJ Corman	1973	Red/White/Black/Gray/Gold	\$679.95
	30138224	RJ Corman	2023	Red/White/Black/Gray/Gold	\$679.95
	30138225	Union Pacific (ONE)	1979	Gray/White/Red/Orange/Blue	\$679.95
	30138226	Union Pacific (Big Boy Escort)	4015	Yellow/Red/Gray	\$679.95
	30138247	Paducah & Louisville	4512	Green/White/Black	\$679.95
	30138248	Paducah & Louisville	4518	Green/White/Black	\$679.95
<b>TOTAL PIECES ORDERED</b>					

### Features:

- Directionally Controlled Headlights
- Intricately Detailed ABS Body
- Metal Wheels, Axles and Gears
- Die-Cast Truck Sides, Pilots and Fuel Tank
- (2) Remotely Controlled Proto-Couplers
- Colorful Paint Scheme
- Metal Chassis
- Metal Handrails and Decorative Horn
- (2) Precision Flywheel Equipped Motors
- Locomotive Speed Control
- Lighted Cab Interior
- Illuminated Number Boards
- (2) Engineer Cab Figures
- Spinning Roof Fans
- Metal Body Side Grilles
- Operating Ditch Lights
- Operating Smoke Unit
- Equipped with Proto-Sound 3
- Unit Measures: 18 1/2" x 2 5/8" x 4"
- Operates On O-42 Curves

"Metra" and "Metra Metropolitan Rail" are registered servicemarks of Metra.

\*\* Prices are subject to change due to board availability/cost.

Atlas Model Railroad Co., Inc. • 378 Florence Ave., Hillside, NJ 07205 • USA • ph: 908-687-0880 • fax: 908-687-8857 / 908-851-2550 • [shop.atlasrr.com](http://shop.atlasrr.com)



# PREMIER CATALOG SPRING 2023 - LOCOMOTIVES

**GUARANTEED PRE-ORDER DUE DATE:  
WEDNESDAY JUNE 7<sup>TH</sup> 2023**



## ATLAS O PREMIER E8 LOCOMOTIVE

Product Info: <https://shop.atlasrr.com/d-693-spring-2023-o-scale-catalog.aspx>

**NEW  
ATLAS O  
MODEL**

*Available in 3-Rail Only.*



Amtrak®



Burlington Northern



NJ Commuter Transition Scheme

Officially licensed by Amtrak





# PREMIER CATALOG SPRING 2023 - LOCOMOTIVES

**GUARANTEED PRE-ORDER DUE DATE:  
WEDNESDAY JUNE 7<sup>TH</sup> 2023**



## ATLAS O PREMIER E8 LOCOMOTIVE

**Product Info:** <https://shop.atlasrr.com/d-693-spring-2023-o-scale-catalog.aspx>

*Perfect match for our Premier Streamlined Passenger Cars  
featured on pages 12-17.*



Penn Central



Rock Island



Kansas City Southern

Officially licensed by Amtrak



# PREMIER CATALOG SPRING 2023 - LOCOMOTIVES

**GUARANTEED PRE-ORDER DUE DATE:  
WEDNESDAY JUNE 7<sup>TH</sup> 2023**



## ATLAS O PREMIER E8 LOCOMOTIVE

**Product Info:** <https://shop.atlasrr.com/d-693-spring-2023-o-scale-catalog.aspx>

In the mid-1930's, as the Electro-Motive Division of General Motors was trying to interest railroads in diesel passenger power, there was a lot of experimentation in exterior design. Looking at EMD's worm-like yellow and brown Union Pacific M-10000, its gleaming stainless steel Burlington Zephyr, or the boxy, just-plain-ugly early Santa Fe units, it's apparent that here was a new function looking for its form. The first generation of road diesels found its form in 1937 when the initial E-units, built for the B&O, inaugurated the classic "covered wagon" cab unit design that would last for two decades on both freight and passenger diesels.

The earliest E-units were each virtually custom-made, with less than 20 units produced of models EA through E5. The prewar E6 was the first mass-produced passenger diesel and the last to sport the rakish, streamlined EMD nose so characteristic of the 1930s. After the war, the new E7 adopted the "bulldog" nose introduced earlier on the FT freight diesel. With the rollout of the E8 in 1949, the E-unit, America's most popular passenger diesel, reached its final visual form — just in time for the last hurrah of the American passenger train. With twin motors to ensure reliability and six-wheel trucks that rode like a Cadillac, the E8 was an engineer's dream. For hoggers who had not long ago worked in steam locomotives, the clean cab of an E-unit with its lofty, panoramic view of the road ahead was not hard to get used to.



### Features:

- Intricately Detailed, Durable ABS Body
- Die-Cast Truck Sides, Pilots and Fuel Tank
- Metal Chassis
- Metal Handrails and Horn
- Moveable Roof Fans
- Metal Body Side Grilles
- (2) Handpainted Engineer Cab Figures
- Authentic Paint Scheme
- Metal Wheels, Axles and Gears
- Lead Remote-Controlled Proto-Coupler
- Rear Non-Operating Metal Coupler
- O Scale Kadee-Compatible Coupler Mounting Pads
- Prototypical Rule 17 Lighting
- Directionally Controlled Constant Voltage LED Headlight
- Lighted LED Cab Interior Light
- Illuminated LED Number Boards
- Lighted LED Front Marker Lights
- (2) Precision Flywheel-Equipped Motors
- Operating ProtoSmoke Diesel Exhaust
- Equipped with Proto-Sound 3
- Locomotive Speed Control In Scale MPH Increments
- 1:48 Scale Proportions
- Equipped with Proto-Sound Unit Measures: 18" x 2 1/2" x 3 7/8"
- Operates On O-31 Curves

*Perfect match for our Premier Streamlined Passenger Cars  
featured on pages 12-17.*



# PREMIER CATALOG SPRING 2023 - LOCOMOTIVES

**GUARANTEED PRE-ORDER DUE DATE:  
WEDNESDAY JUNE 7<sup>TH</sup> 2023**



## ATLAS O PREMIER E8 LOCOMOTIVE

Product Info: <https://shop.atlasrr.com/d-693-spring-2023-o-scale-catalog.aspx>

### POWERED UNITS

ESTIMATED ARRIVAL: **2nd Quarter 2024**

ORDER IN PIECES	3-RAIL ITEM	ROAD NAME	ROAD NUMBER	COLORS	MSRP/ UNIT
	30138229	Amtrak®	203	Silver/Red/Blue	\$599.95
	30138230	Amtrak®	205	Silver/Red/Blue	\$599.95
	30138231	Burlington Northern	9902	Green/White	\$599.95
	30138232	Burlington Northern	9904	Green/White	\$599.95
	30138233	NJ Commuter Transition Scheme	4248	Blue/Silver/Red	\$599.95
	30138234	NJ Commuter Transition Scheme	4305	Blue/Silver/Red	\$599.95
	30138235	Penn Central	4064	Black/White	\$599.95
	30138236	Penn Central	4076	Black/White	\$599.95
	30138237	Rock Island	646	Red/Yellow	\$599.95
	30138238	Rock Island	654	Red/Yellow	\$599.95
	30138239	Kansas City Southern	25	Green/Yellow/Red	\$599.95
	30138240	Kansas City Southern	27	Green/Yellow/Red	\$599.95
<b>TOTAL PIECES ORDERED</b>					

*Available in 3-Rail Only.*

### UNPOWERED UNITS

ESTIMATED ARRIVAL: **2nd Quarter 2024**

ORDER IN PIECES	3-RAIL ITEM	ROAD NAME	ROAD NUMBER	COLORS	MSRP/ UNIT
	30138241	Amtrak®	407	Silver/Red/Blue	\$279.95
	30138242	Penn Central	4274	Black/White	\$279.95
	30138243	Rock Island	652	Red/Yellow	\$279.95
	30138244	Kansas City Southern	29	Green/Yellow/Red	\$279.95
<b>TOTAL PIECES ORDERED</b>					

Officially licensed by Amtrak

\*\* Prices are subject to change due to board availability/cost.



# PREMIER CATALOG SPRING 2023- ROLLING STOCK

**GUARANTEED PRE-ORDER DUE DATE:  
WEDNESDAY JUNE 7<sup>TH</sup> 2023**



## ATLAS O PREMIER STREAMLINED PASSENGER CAR

**NEW  
ATLAS O  
MODEL**

Product Info: <https://shop.atlasrr.com/d-693-spring-2023-o-scale-catalog.aspx>

### *4 Car Sets*



Amtrak® 4 car set



Burlington Northern 4 car set



NJ Commuter Transition Scheme 4 car set



Penn Central 4 car set



Kansas City Southern 4 car set



Rock Island 4 car set

Officially licensed by Amtrak

Atlas Model Railroad Co., Inc. • 378 Florence Ave., Hillside, NJ 07205 • USA • ph: 908-687-0880 • fax: 908-687-8857 / 908-851-2550 • [shop.atlasrr.com](http://shop.atlasrr.com)



# PREMIER CATALOG SPRING 2023- ROLLING STOCK

**GUARANTEED PRE-ORDER DUE DATE:  
WEDNESDAY JUNE 7<sup>TH</sup> 2023**



## ATLAS O PREMIER STREAMLINED PASSENGER CAR

Product Info: <https://shop.atlasrr.com/d-693-spring-2023-o-scale-catalog.aspx>

*Perfect match for our Premier E8 Locomotives featured on pages 8-11.*





# PREMIER CATALOG SPRING 2023- ROLLING STOCK

**GUARANTEED PRE-ORDER DUE DATE:  
WEDNESDAY JUNE 7<sup>TH</sup> 2023**



## ATLAS O PREMIER STREAMLINED PASSENGER CAR

**NEW  
ATLAS O  
MODEL**

Product Info: <https://shop.atlasrr.com/d-693-spring-2023-o-scale-catalog.aspx>

### *2 Car Sets*

*Perfect match for our Premier E8 Locomotives featured on pages 8-11.*



Amtrak® 2 car set



Burlington Northern 2 car set



NJ Commuter Transition Scheme 2 car set



Penn Central 2 car set



Rock Island 2 car set

Officially licensed by Amtrak

Atlas Model Railroad Co., Inc. • 378 Florence Ave., Hillside, NJ 07205 • USA • ph: 908-687-0880 • fax: 908-687-8857 / 908-851-2550 • [shop.atlasrr.com](http://shop.atlasrr.com)



# PREMIER CATALOG SPRING 2023- ROLLING STOCK

**GUARANTEED PRE-ORDER DUE DATE:  
WEDNESDAY JUNE 7<sup>TH</sup> 2023**



## ATLAS O PREMIER STREAMLINED PASSENGER CAR

Product Info: <https://shop.atlasrr.com/d-693-spring-2023-o-scale-catalog.aspx>

### Single Cars

*Perfect match for our Premier E8 Locomotives featured on pages 8-11.*



Amtrak®



Burlington Northern



NJ Commuter Transition Scheme



Kansas City Southern

Officially licensed by Amtrak

Atlas Model Railroad Co., Inc. • 378 Florence Ave., Hillside, NJ 07205 • USA • ph: 908-687-0880 • fax: 908-687-8857 / 908-851-2550 • [shop.atlasrr.com](http://shop.atlasrr.com)



# PREMIER CATALOG SPRING 2023- ROLLING STOCK

**GUARANTEED PRE-ORDER DUE DATE:  
WEDNESDAY JUNE 7<sup>TH</sup> 2023**



## ATLAS O PREMIER STREAMLINED PASSENGER CAR

Product Info: <https://shop.atlasrr.com/d-693-spring-2023-o-scale-catalog.aspx>

### FOUR CAR SETS

ESTIMATED ARRIVAL: **2nd Quarter 2024**

ORDER IN PIECES	3-RAIL ITEM	ROAD NAME/ROAD NUMBER	COLORS	MSRP/UNIT
	3001474	Amtrak® (Phase 1) 4 car set includes: 70' Streamline Baggage - 1007 Silver Treasure; 70' Streamline Coach - 4822; 70' Streamline Vista Dome - 9401 Silver Dome; 70' Streamline Observation - 3342	Silver/Red/White/Blue	\$479.80
	3001477	Burlington Northern 4 car set includes: 70' Streamline Baggage - 676; 70' Streamline Coach - 1116; 70' Streamline Coach - 1139; 70' Streamline Full Vista Dome - 1395 River View	Green/White	\$479.80
	3001480	NJ Commuter Transition Scheme 4 car set includes: 70' Streamline Coach - 3070; 70' Streamline Coach - 3089; 70' Streamline Coach - 3092; 70' Streamline Coach - 3093	Silver	\$479.80
	3001483	Penn Central 4 car set includes: 70' Streamline Coach - 1589; 70' Streamline Coach - 2531; 70' Streamline Coach - 1596; 70' Streamline Observation - 4424	Silver/Black	\$479.80
	3001485	Kansas City Southern 4 car set includes: 70' Streamline Baggage - 20; 70' Streamline Coach - 273; 70' Streamline Coach - 277; 70' Streamline Observation - 40	Green/Yellow/Red	\$479.80
	3001487	Rock Island 4 car set includes: 70' Streamline Baggage - 855; 70' Streamline Coach - Davenport; 70' Streamline Coach - Herington; 70' Streamline Observation - Centennial	Silver/ Black	\$479.80
<b>TOTAL PIECES ORDERED</b>				

### TWO CAR SETS

ESTIMATED ARRIVAL: **2nd Quarter 2024**

ORDER IN PIECES	3-RAIL ITEM	ROAD NAME/ROAD NUMBER	COLORS	MSRP/UNIT
	3001475	Amtrak® 2 car set includes: 70' Streamline Sleeper 2150 Silver Flower; 70' Streamline Diner 8055 Silver Tureen	Silver/Red/White/Blue	\$239.90
	3001478	Burlington Northern 2 car set includes: 70' Streamline Vista Dome 4735 Silver Buckle; Streamline Vista Dome 4736 Silver Brand	Silver	\$239.90
	3001481	NJ Commuter Transition Scheme 2 car set includes: 70' Steamline Coach 3072; 70' Steamline Coach 3079	Silver	\$239.90
	3001484	Penn Central 2 car set includes: 70' Streamline Coach 2167; 70' Streamline Coach 2177	Silver/Black	\$239.90
	3001488	Rock Island 2 car set includes: 70' Streamline Diner Golden Banquet; 70' Steamline Sleeper Golden Meadow	Silver/Black	\$239.90
<b>TOTAL PIECES ORDERED</b>				

Officially licensed by Amtrak





# PREMIER CATALOG SPRING 2023- ROLLING STOCK

**GUARANTEED PRE-ORDER DUE DATE:  
WEDNESDAY JUNE 7<sup>TH</sup> 2023**



## ATLAS O PREMIER STREAMLINED PASSENGER CAR

**Product Info:** <https://shop.atlasrr.com/d-693-spring-2023-o-scale-catalog.aspx>

### SINGLE CARS

**ESTIMATED ARRIVAL: 2nd Quarter 2024**

ORDER IN PIECES	3-RAIL ITEM	ROAD NAME/ROAD NUMBER	COLORS	MSRP/UNIT
	3001476	Amtrak® 70' Streamline Full Vista Dome 9361 Ocean View	Silver/Red/White/Blue	\$119.95
	3001479	Burlington Northern 70' Streamline Diner 1154 Lake Michigan	Green/White	\$119.95
	3001482	NJ Commuter Transition Scheme 70' Streamline Diner 5450	Silver	\$119.95
	3001486	Kansas City Southern 70' Streamline Sleeper Colonel Fordyce	Green/Yellow/Red	\$119.95
<b>TOTAL PIECES ORDERED</b>				

The lightweight, streamlined passenger car was a product of the Great Depression. While the heavyweight steel cars built in the teens and 1920s were dependable and often luxurious, their dark colors and solid, battleship-like exteriors did little to lift the spirits at a time when the entire nation needed a pick-me-up. As noted railroad historian John H. White, Jr. put it in *The American Railroad Passenger Car*, "Some hope during these gloomy years was offered by a new design concept called streamlining. It presented a sleek, modern image of speed and innovation. What had been an obscure technical term in aerodynamics was made into a household word through an astute publicity campaign mounted by several railroad traffic departments. It succeeded in creating a general interest in railroading practically unknown since the opening of the first transcontinental line... According to *Railway Age*, 'For the first time in many years, the words 'sold out' re-entered the ticket clerk's vocabulary.'"

But as White notes, the real change in passenger car construction was in weight, not the streamlined appearance that was largely for show: "Weight, not air friction, was the chief obstacle to economic operation." Unlike the heavyweights, the lightweight cars that debuted in the mid-1930s featured sides and roofs that contributed to their structural strength, eliminating the need for the heavyweights' massive underframes. Trucks went from six wheels to four, non-revenue space was decreased by using a vestibule on only one end of the car, and lighter, stronger, more rust resistant steel alloys came into widespread use. A typical new lightweight could be 15-20 tons lighter than the heavyweight car it replaced.

The majority of lightweights were 80'-85' long, which scales out to about 21" in O gauge. Many O gauge modelers, however, find cars of this length impractical, as they require large curves and create long trains that can overwhelm a typical-sized layout. For those reasons, our Premier lightweights are about 70 scale feet in length — reproducing the look and feel of prototype streamliners in a model that will round O-42 curves with ease and look at home on most scale-detailed O gauge layouts.

#### Features:

- Intricately Detailed, Durable ABS Bodies
- Stamped Metal Floors
- Detailed Car Undercarriage
- Colorful, Attractive Paint Schemes
- Metal Wheels and Axles
- Die-Cast 4-Wheel Trucks
- Fast-Angle Wheel Sets
- Needle-Point Axles
- (2) Operating Die-Cast Metal Couplers
- O Scale Kadee-Compatible Coupler Mounting Pads
- Constant Voltage Overhead LED Interior Lighting
- End-of-Car Diaphragms
- Separate Metal Handrails
- Detailed Car Interiors
- Sliding Baggage Car Doors
- Detailed Brake Wheel
- 1:48 Scale Proportions
- Unit Measures: 19" x 2 7/16" x 3 1/2"
- Operates On O-42 Curves



# PREMIER CATALOG SPRING 2023- ROLLING STOCK

**GUARANTEED PRE-ORDER DUE DATE:  
WEDNESDAY JUNE 7<sup>TH</sup> 2023**



## ATLAS O PREMIER RAPID DISCHARGE HOPPER

Product Info: <https://shop.atlasrr.com/d-693-spring-2023-o-scale-catalog.aspx>

**NEW  
ATLAS O  
MODEL**



Amtrak®



Bessemer & Lake Erie (CN)



Florida East Coast



GATX



Chessie System\* (C&O)



Southern Pacific

*\*CSX Licensed Product  
Officially licensed by Amtrak*



# PREMIER CATALOG SPRING 2023- ROLLING STOCK

**GUARANTEED PRE-ORDER DUE DATE:  
WEDNESDAY JUNE 7<sup>TH</sup> 2023**



## ATLAS O PREMIER RAPID DISCHARGE HOPPER

**Product Info:** <https://shop.atlasrr.com/d-693-spring-2023-o-scale-catalog.aspx>

**ESTIMATED ARRIVAL: 2nd Quarter 2024**

ORDER IN PIECES	3-RAIL ITEM	ROAD NAME	ROAD NUMBER	COLORS	MSRP / UNIT
	3001460	Amtrak®	12558, 12560, 12475, 12769	Yellow/Black	\$84.95
	3001461	Bessemer & Lake Erie (CN)	35045, 35060, 35069,35087	Black/White	\$84.95
	3001462	Florida East Coast	15312, 15373, 15376, 15393	Brown/White	\$84.95
	3001463	GATX	171, 181, 200, 217	Blue/White	\$84.95
	3001464	Chessie System* (C&O)	45035, 45050, 45069, 45087	Black/Yellow	\$84.95
	3001465	Southern Pacific	481317, 481325, 481369, 481388	Red/White	\$84.95
<b>TOTAL PIECES ORDERED</b>					

**ESTIMATED ARRIVAL: 2nd Quarter 2024**

ORDER IN PIECES	2-RAIL ITEM	ROAD NAME	ROAD NUMBER	COLORS	MSRP / UNIT
	3002460	Amtrak®	12558, 12560, 12475, 12769	Yellow/Black	\$89.95
	3002461	Bessemer & Lake Erie (CN)	35045, 35060, 35069,35087	Black/White	\$89.95
	3002462	Florida East Coast	15312, 15373, 15376, 15393	Brown/White	\$89.95
	3002463	GATX	171, 181, 200, 217	Blue/White	\$89.95
	3002464	Chessie System* (C&O)	45035, 45050, 45069, 45087	Black/Yellow	\$89.95
	3002465	Southern Pacific	481317, 481325, 481369, 481388	Red/White	\$89.95
<b>TOTAL PIECES ORDERED</b>					

The Rapid Discharge Hopper, designed for heavy, dense loads like sand, gravel, limestone, and other aggregates, was designed and built by the Ortner Freight Car Co. (Now part of the TrinityRail® group). Thanks to its steep 60-degree end sheets and Rapid Discharge hopper door system, the car unloads completely in less than 30 seconds without the need for a car shaker. An entire unit train of these cars can be unloaded in 30 to 60 minutes, whereas other unloading systems could take 4 hours or longer. The design has stood the test of time, as these cars are still in service on many railroads nationwide.

### Features:

- Intricately Detailed Durable ABS Body
- Metal Wheels and Axles
- Die-Cast 4-Wheel Trucks
- Operating Die-Cast Metal Couplers
- Colorful, Attractive Paint Schemes
- Separate Metal Handrails
- Fast-Angle Wheel Sets
- Needle-Point Axles
- 1:48 Scale Dimensions
- Unit Measures: 11 1/4" x 2 9/16" x 3 3/8"
- Operates On 0-31 Curves (3-Rail), 24" radius (2-Rail)

*\*CSX Licensed Product  
Officially licensed by Amtrak*



# PREMIER CATALOG SPRING 2023- ROLLING STOCK

**GUARANTEED PRE-ORDER DUE DATE:  
WEDNESDAY JUNE 7<sup>TH</sup> 2023**



## ATLAS O PREMIER 2-BAY OFFSET HOPPER

**NEW  
PAINT  
SCHEMES**

Product Info: <https://shop.atlasrr.com/d-693-spring-2023-o-scale-catalog.aspx>



Chicago & Eastern Illinois



Baltimore & Ohio\*



Maine Central



Milwaukee Road

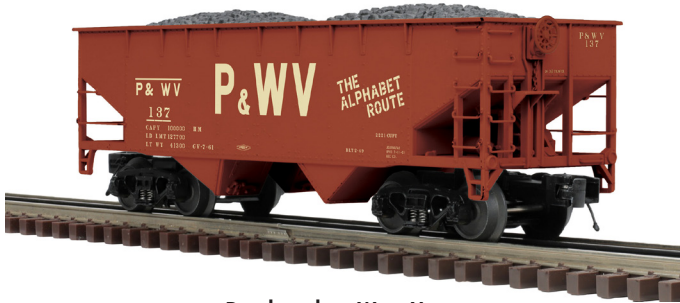

Pittsburgh & West Virginia



Richmond, Fredericksburg & Potomac

*\*CSX Licensed Product*

### NEW LIMITED EDITION COLLECTORS SERIES† PAINT SCHEME

†Atlas' Limited Edition Collectors' Series paint schemes will be run one time only!

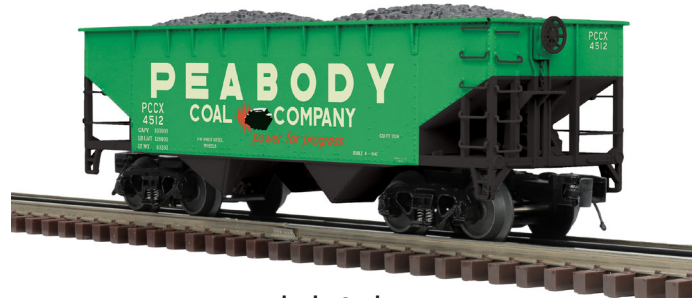

Peabody Coal



# PREMIER CATALOG SPRING 2023- ROLLING STOCK

**GUARANTEED PRE-ORDER DUE DATE:  
WEDNESDAY JUNE 7<sup>TH</sup> 2023**



## ATLAS O PREMIER 2-BAY OFFSET HOPPER

**Product Info:** <https://shop.atlasrr.com/d-693-spring-2023-o-scale-catalog.aspx>

**ESTIMATED ARRIVAL: 2nd Quarter 2024**

ORDER IN PIECES	3-RAIL ITEM	ROAD NAME	ROAD NUMBER	COLORS	MSRP / UNIT
<b>NEW PAINT SCHEMES</b>					
	3001390	Chicago and Eastern Illinios (CE&I)	96128, 96157, 96201, 96227	Brown/White	\$82.95
	3001391	Baltimore & Ohio*	235623, 235638, 235641, 235655	Black/White	\$82.95
	3001392	Maine Central	3723, 3735, 3749, 3754	Black/Harvest Gold/Green	\$82.95
	3001393	Milwaukee Road	94253, 94304, 94537, 94588	Brown/White	\$82.95
	3001394	Pittsburgh & West Virginia	137, 142, 154, 163	Brown/Tan	\$82.95
	3001395	Richmond, Fredericksburg & Potomac	7017, 7021, 7034, 7047	Black/White	\$82.95
<b>NEW LIMITED EDITION COLLECTORS SERIES<sup>1</sup> PAINT SCHEME</b>					
	3001396	Peabody Coal	4512, 4525	Green/Yellow/Red/White	\$82.95
<b>TOTAL PIECES ORDERED</b>					

**ESTIMATED ARRIVAL: 2nd Quarter 2024**

ORDER IN PIECES	2-RAIL ITEM	ROAD NAME	ROAD NUMBER	COLORS	MSRP / UNIT
<b>NEW PAINT SCHEMES</b>					
	3002390	Chicago and Eastern Illinios (CE&I)	96128, 96157, 96201, 96227	Brown/White	\$87.95
	3002391	Baltimore & Ohio*	235623, 235638, 235641, 235655	Black/White	\$87.95
	3002392	Maine Central	3723, 3735, 3749, 3754	Black/Harvest Gold/Green	\$87.95
	3002393	Milwaukee Road	94253, 94304, 94537, 94588	Brown/White	\$87.95
	3002394	Pittsburgh & West Virginia	137, 142, 154, 163	Brown/Tan	\$87.95
	3002395	Richmond, Fredericksburg & Potomac	7017, 7021, 7034, 7047	Black/White	\$87.95
<b>NEW LIMITED EDITION COLLECTORS SERIES<sup>1</sup> PAINT SCHEME</b>					
	3002396	Peabody Coal	4512, 4525	Green/Yellow/Red/White	\$87.95
<b>TOTAL PIECES ORDERED</b>					

The Association of American Railroads (AAR) developed a standard design for 50-ton and 70-ton twin offset open hopper cars starting in the late 1920s. The design was modified in the mid 1930s, and through 1960 over 127,000 cars had been built to AAR specifications. Eastern coal carriers amassed the largest fleets - however, the twin offset hopper design was not limited to coal service, with ore and aggregates also being hauled.

They could also be found operating in a wide range of services including unit coal trains, blocks of loaded cars destined to a large consignee, and even "loose" single cars headed to smaller customers.

**Features:**

- Intricately Detailed, Durable ABS Body
- Metal Wheels and Axles
- Die-Cast 4-Wheel Trucks
- Fast-Angle Wheel Sets
- Needle-Point Axles
- Removable coal load included
- (2) Operating Die-Cast Metal Couplers
- O Scale Kadee-Compatible Coupler Mounting Pads
- Detailed Brake Wheel
- Separate Metal Handrails
- 1:48 Scale Dimensions
- Unit Measures: 9 1/2" x 2 1/2" x 3"
- Operates On O-31 Curves

*\*CSX Licensed Product*

Atlas Model Railroad Co., Inc. • 378 Florence Ave., Hillside, NJ 07205 • USA • ph: 908-687-0880 • fax: 908-687-8857 / 908-851-2550 • [shop.atlasrr.com](https://shop.atlasrr.com)



# PREMIER CATALOG SPRING 2023- ROLLING STOCK

**GUARANTEED PRE-ORDER DUE DATE:  
WEDNESDAY JUNE 7<sup>TH</sup> 2023**



## ATLAS MASTER® 3 & 6 BAY CYLINDRICAL HOPPERS

**NEW  
PAINT  
SCHEMES**

Product Info: <https://shop.atlasrr.com/d-693-spring-2023-o-scale-catalog.aspx>



Cargill Salt



J.M. Huber

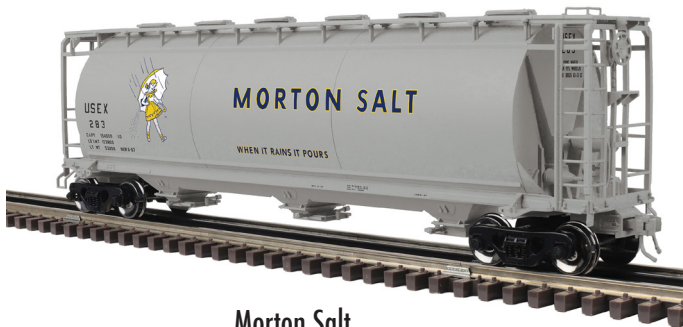

Morton Salt



Santa Fe



Sid Richardson



Norfolk & Western

### NEW LIMITED EDITION COLLECTORS SERIES† PAINT SCHEME

†Atlas' Limited Edition Collectors' Series paint schemes will be run one time only!



Burlington Northern Bicentennial



# PREMIER CATALOG SPRING 2023- ROLLING STOCK

**GUARANTEED PRE-ORDER DUE DATE:  
WEDNESDAY JUNE 7<sup>TH</sup> 2023**



## ATLAS MASTER® 3 & 6 BAY CYLINDRICAL HOPPERS

**Product Info:** <https://shop.atlasrr.com/d-693-spring-2023-o-scale-catalog.aspx>

**ESTIMATED ARRIVAL: 2nd Quarter 2024**

ORDER IN PIECES	3-RAIL ITEM	ROAD NAME	ROAD NUMBER	COLORS	MSRP/UNIT
<b>NEW PAINT SCHEMES - 3 BAY CYLINDRICAL HOPPER</b>					
	3001440	Cargill Salt	62802, 62810	Green/White	\$84.95
	3001441	J.M. Huber	60254, 60257	Gray/Black	\$84.95
	3001442	Morton Salt	283, 287	Gray/Yellow/Blue	\$84.95
	3001443	Santa Fe	301291, 301294	Black/Orange	\$84.95
	3001444	Sid Richardson	354, 359	Black/White	\$84.95
<b>NEW PAINT SCHEMES - 6 BAY CYLINDRICAL HOPPER</b>					
	3001445	Norfolk & Western	332956, 332958	Gray/Black	\$84.95
<b>NEW LIMITED EDITION COLLECTORS SERIES<sup>1</sup> PAINT SCHEME - 6 BAY CYLINDRICAL HOPPER</b>					
	3001446	Burlington Northern Bicentennial	443056	White/Red/Blue	\$84.95
<b>TOTAL PIECES ORDERED</b>					

**ESTIMATED ARRIVAL: 2nd Quarter 2024**

ORDER IN PIECES	2-RAIL ITEM	ROAD NAME	ROAD NUMBER	COLORS	MSRP/UNIT
<b>NEW PAINT SCHEMES - 3 BAY CYLINDRICAL HOPPER</b>					
	3002440	Cargill Salt	62802, 62810	Green/White	\$89.95
	3002441	J.M. Huber	60254, 60257	Gray/Black	\$89.95
	3002442	Morton Salt	283, 287	Gray/Yellow/Blue	\$89.95
	3002443	Santa Fe	301291, 301294	Black/Orange	\$89.95
	3002444	Sid Richardson	354, 359	Black/White	\$89.95
<b>NEW PAINT SCHEMES - 6 BAY CYLINDRICAL HOPPER</b>					
	3002445	Norfolk & Western	332956, 332958	Gray/Black	\$89.95
<b>NEW LIMITED EDITION COLLECTORS SERIES<sup>1</sup> PAINT SCHEME - 6 BAY CYLINDRICAL HOPPER</b>					
	3002446	Burlington Northern Bicentennial	443056	White/Red/Blue	\$89.95
<b>TOTAL PIECES ORDERED</b>					

Introduced in 1961 by ACF® to haul sand, clay, salt, grain and bulk plastics, the Cylindrical Hopper was the first commercially successful tank-type covered hopper car design. A few of the more than 4,000 cars of this type built through 1966 can still be seen in service today across the United States.

**Features:**

- Accurate painting and lettering with true ¼" dimensions and details
- Spring die-cast 100-ton roller-bearing trucks with rotating bearing caps
- Opening hatches
- Realistic see through roof walks
- Separately-applied grab irons & brake detail
- Die-cast articulated couplers (3-rail)
- 3 Bay Minimum radius curve: 0-31 (3-rail)/6 Bay Minimum radius curve: 0-42 (3-rail)

Atlas Model Railroad Co., Inc. • 378 Florence Ave., Hillside, NJ 07205 • USA • ph: 908-687-0880 • fax: 908-687-8857 / 908-851-2550 • [shop.atlasrr.com](http://shop.atlasrr.com)



# PREMIER CATALOG SPRING 2023- ROLLING STOCK

**GUARANTEED PRE-ORDER DUE DATE:  
WEDNESDAY JUNE 7<sup>TH</sup> 2023**



## ATLAS MASTER® O TRINITY 17,600 GALLON CORN SYRUP TANK CAR

Product Info: <https://shop.atlasrr.com/d-693-spring-2023-o-scale-catalog.aspx>

**NEW  
PAINT SCHEMES &  
NEW ROAD  
NUMBERS**



GATX



Tate & Lyle



US Army+ (Red)



US Army+ (Yellow)



ADM (Leaf & Conspicuity Stripes)



Minnesota Corn Processors

*+paint scheme accurate for a similar prototype*





# PREMIER CATALOG SPRING 2023- ROLLING STOCK

**GUARANTEED PRE-ORDER DUE DATE:  
WEDNESDAY JUNE 7<sup>TH</sup> 2023**



## ATLAS MASTER® O TRINITY 17,600 GALLON CORN SYRUP TANK CAR

Product Info: <https://shop.atlasrr.com/d-693-spring-2023-o-scale-catalog.aspx>

**ESTIMATED ARRIVAL: 2nd Quarter 2024**

ORDER IN PIECES	3-RAIL ITEM	ROAD NAME	ROAD NUMBER	COLORS	MSRP / UNIT
<b>NEW PAINT SCHEMES</b>					
	3001454	GATX	4827, 4856	Black/White/Yellow	\$89.95
	3001455	Tate & Lyle	1530, 1634	Black/White/Silver	\$89.95
	3001456	US Army+ (Red)	18600, 18602	Red/Gray	\$89.95
	3001457	US Army+ (Yellow)	18599, 18601	Yellow/Gray	\$89.95
<b>NEW ROAD NUMBERS</b>					
	3001458	ADM (Leaf and Conspicuity Stripes)	17269, 17283	Black/White/Blue/Green	\$89.95
	3001459	Minnesota Corn Processors (MNCX)	1008, 1012	Black/White/Yellow/Green	\$89.95
<b>TOTAL PIECES ORDERED</b>					

**ESTIMATED ARRIVAL: 2nd Quarter 2024**

ORDER IN PIECES	2-RAIL ITEM	ROAD NAME	ROAD NUMBER	COLORS	MSRP / UNIT
<b>NEW PAINT SCHEMES</b>					
	3002454	GATX	4827, 4856	Black/White/Yellow	\$94.95
	3002455	Tate & Lyle	1530, 1634	Black/White/Silver	\$94.95
	3002456	US Army+ (Red)	18600, 18602	Red/Gray	\$94.95
	3002457	US Army+ (Yellow)	18599, 18601	Yellow/Gray	\$94.95
<b>NEW ROAD NUMBERS</b>					
	3002458	ADM (Leaf and Conspicuity Stripes)	17269, 17283	Black/White/Blue/Green	\$94.95
	3002459	Minnesota Corn Processors (MNCX)	1008, 1012	Black/White/Yellow/Green	\$94.95
<b>TOTAL PIECES ORDERED</b>					

The prototype for the 17,600 Gallon Corn Syrup Tank Car was built in large numbers by Trinity Industries between 1984 and 1998. Of the over 7,000 cars that were built, most are still in active service today. The cars followed a common bent-barrel tank design that helps the product drain and unload easier. These cars are jacketed and insulated, and have exterior coil pipes to heat the commodity to promote faster unloading. Midland food-grade butterfly unload valves and Midland exterior spring safety valves were common appliances used on these cars. The biggest variation in the car production was in the manway / top platform arrangement. Several arrangements were specified by large shippers; for example ADM, Cargill, Corn Products, GATX, MCP, and Staley to name a few. These tank cars are commonly used to transport varying grades of Corn Syrup, Liquid Sugar, and Molasses from processing facilities to bulk distribution centers and other end-users throughout the US and Canada. They are a very common sight on today's railroads, and they have been for two decades. This initial release features three of the most common manway/top platform arrangements as specified by ADM, Cargill, and Corn Products (among others).

### Features:

- Separately applied detail such as: train line hoses, coupler cut levers, brake rigging, bottom outlet valve & valve handle, & metal grab irons
- 100 ton roller bearing trucks with rotating bearing caps
- Accurate painting and printing
- Highly detailed body with prototypical jacket seams
- See-through walkway and platforms
- Overall length: 10 1/4"
- Minimum diameter curve (3-rail): 0-36
- Minimum radius curve (2-rail): 24"

*+paint scheme accurate for a similar prototype*

Atlas Model Railroad Co., Inc. • 378 Florence Ave., Hillside, NJ 07205 • USA • ph: 908-687-0880 • fax: 908-687-8857 / 908-851-2550 • [shop.atlasrr.com](http://shop.atlasrr.com)



# PREMIER CATALOG SPRING 2023- ROLLING STOCK

**GUARANTEED PRE-ORDER DUE DATE:  
WEDNESDAY JUNE 7<sup>TH</sup> 2023**



## ATLAS MASTER® O BERWICK 60' HY-CUBE BOX CAR

**NEW  
PAINT SCHEMES &  
NEW ROAD  
NUMBERS**

Product Info: <https://shop.atlasrr.com/d-693-spring-2023-o-scale-catalog.aspx>



Conrail



Detroit, Toledo & Ironton



Louisville & Nashville\*



Union Pacific



Norfolk Southern

*\*CSX Licensed Product*

## NEW LIMITED EDITION COLLECTORS SERIES† PAINT SCHEMES

†Atlas' Limited Edition Collectors' Series paint schemes will be run one time only!



Rio Grande



Union Pacific (ONE)



# PREMIER CATALOG SPRING 2023- ROLLING STOCK

**GUARANTEED PRE-ORDER DUE DATE:  
WEDNESDAY JUNE 7<sup>TH</sup> 2023**



## ATLAS MASTER® O BERWICK 60' HY-CUBE BOX CAR

Product Info: <https://shop.atlasrr.com/d-693-spring-2023-o-scale-catalog.aspx>

**ESTIMATED ARRIVAL: 2nd Quarter 2024**

ORDER IN PIECES	3-RAIL ITEM	ROAD NAME	ROAD NUMBER	COLORS	MSRP/ UNIT
<b>NEW PAINT SCHEMES</b>					
	3001447	Conrail	223007, 223015	Brown	\$89.95
	3001448	Detroit, Toledo & Ironton	25952, 25964	Green	\$89.95
	3001449	Louisville & Nashville*	420012, 420031	Blue	\$89.95
	3001450	Union Pacific	960867, 960879	Yellow	\$89.95
<b>NEW ROAD NUMBERS</b>					
	3001451	Norfolk Southern	468127, 468145	Brown	\$89.95
<b>NEW LIMITED EDITION COLLECTORS SERIES<sup>†</sup> PAINT SCHEMES</b>					
	3001452	Rio Grande	63897, 63899	Orange/White/Black	\$89.95
	3001453	Union Pacific (ONE)	197999	Gray/White/Red/Orange/Blue	\$89.95
<b>TOTAL PIECES ORDERED</b>					

**ESTIMATED ARRIVAL: 2nd Quarter 2024**

ORDER IN PIECES	2-RAIL ITEM	ROAD NAME	ROAD NUMBER	COLORS	MSRP/ UNIT
<b>NEW PAINT SCHEMES</b>					
	3002447	Conrail	223007, 223015	Brown	\$94.95
	3002448	Detroit, Toledo & Ironton	25952, 25964	Green	\$94.95
	3002449	Louisville & Nashville*	420012, 420031	Blue	\$94.95
	3002450	Union Pacific	960867, 960879	Yellow	\$94.95
<b>NEW ROAD NUMBERS</b>					
	3002451	Norfolk Southern	468127, 468145	Brown	\$94.95
<b>NEW LIMITED EDITION COLLECTORS SERIES<sup>†</sup> PAINT SCHEMES</b>					
	3002452	Rio Grande	63897, 63899	Orange/White/Black	\$94.95
	3002453	Union Pacific (ONE)	197999	Gray/White/Red/Orange/Blue	\$94.95
<b>TOTAL PIECES ORDERED</b>					

Berwick Forge & Fabricating built over 23,000 freight cars in its nearly 20 years of existence in Berwick, Pennsylvania. Their designs were very successful and most of the cars are still in service today. While Berwick built virtually all modern types of freight cars, they are perhaps best known for their 50' and 60' box cars.

This Atlas O model replicates the interesting series of 60' high-capacity cars that were built by Berwick in the late 70s. These Hy-Cube cars feature centered double plug-doors and a waffle pattern on the car sides.

**Features:**

- Intricately-detailed ABS body
- Etched metal safety platforms
- Finely die-cast metal ladders and stirrups
- Highly-detailed die-cast underframe
- Accurate painting and lettering
- 100-ton roller-bearing trucks with rotating bearing caps
- Simulated paint overspray on roof
- Minimum diameter curve: 0-54 (3-Rail)
- Minimum radius curve: 36" (2-Rail)

*\*CSX Licensed Product*

Atlas Model Railroad Co., Inc. • 378 Florence Ave., Hillside, NJ 07205 • USA • ph: 908-687-0880 • fax: 908-687-8857 / 908-851-2550 • [shop.atlasrr.com](http://shop.atlasrr.com)



# PREMIER CATALOG SPRING 2023- ROLLING STOCK

**GUARANTEED PRE-ORDER DUE DATE:  
WEDNESDAY JUNE 7<sup>TH</sup> 2023**



## ATLAS TRAINMAN® O 40' STOCK CAR

Product Info: <https://shop.atlasrr.com/d-693-spring-2023-o-scale-catalog.aspx>

**NEW  
PAINT SCHEMES &  
NEW ROAD  
NUMBERS**



Chicago, Burlington and Quincy



Canadian Pacific (CP Rail)



Ferrocarril Del Pacifico (FCP)



Union Pacific (UP) Livestock



Santa Fe (ATSF)



Rio Grande (DRGW)



# PREMIER CATALOG SPRING 2023- ROLLING STOCK

**GUARANTEED PRE-ORDER DUE DATE:  
WEDNESDAY JUNE 7<sup>TH</sup> 2023**



## ATLAS TRAINMAN® O 40' STOCK CAR

Product Info: <https://shop.atlasrr.com/d-693-spring-2023-o-scale-catalog.aspx>

**ESTIMATED ARRIVAL: 2nd Quarter 2024**

ORDER IN PIECES	3-RAIL ITEM	ROAD NAME	ROAD NUMBER	COLORS	MSRP / UNIT
<b>NEW PAINT SCHEMES</b>					
	2002417	Chicago, Burlington and Quincy (CBQ)	53061D, 53066D	Green / White	\$69.95
	2002412	Canadian Pacific (CP Rail)	278521, 278530	Red / Gray / White	\$69.95
	2002413	Ferrocarril Del Pacifico (FCP)	7233, 7239	Green / Yellow / Orange	\$69.95
	2002414	Union Pacific (UP) Livestock Dispatch	47456D, 47630D	Yellow / Red / Silver	\$69.95
<b>NEW ROAD NUMBERS</b>					
	2002415	Santa Fe (ATSF)	27872, 28117	Brown / White	\$69.95
	2002416	Rio Grande (DRGW)	36411D, 36498D	Black / White	\$69.95
<b>TOTAL PIECES ORDERED</b>					

**ESTIMATED ARRIVAL: 2nd Quarter 2024**

ORDER IN PIECES	2-RAIL ITEM	ROAD NAME	ROAD NUMBER	COLORS	MSRP / UNIT
<b>NEW PAINT SCHEMES</b>					
	2002467	Chicago, Burlington and Quincy (CBQ)	53061D, 53066D	Green / White	\$72.95
	2002462	Canadian Pacific (CP Rail)	278521, 278530	Red / Gray / White	\$72.95
	2002463	Ferrocarril Del Pacifico (FCP)	7233, 7239	Green / Yellow / Orange	\$72.95
	2002464	Union Pacific (UP) Livestock Dispatch	47456D, 47630D	Yellow / Red / Silver	\$72.95
<b>NEW ROAD NUMBERS</b>					
	2002465	Santa Fe (ATSF)	27872, 28117	Brown / White	\$72.95
	2002466	Rio Grande (DRGW)	36411D, 36498D	Black / White	\$72.95
<b>TOTAL PIECES ORDERED</b>					

During the heyday of rail transport, livestock was routinely shipped in complete trainloads to packing plants throughout the country. The typical stock car was based upon a 40' box car modified with open slat sides and possibly internal decking for the smaller breeds of animals. Designed primarily for transporting cows and pigs, original stock cars date back to the 1860's, and could carry up to 20,000 pounds of livestock. Their use became rare by the 1980's, due to humane, safety and cost concerns. This ATLAS O TRAINMAN® model is a typical reproduction of a once-common freight car style. Resplendent with eye-popping details and engineered for reliability and historical accuracy, this model is a must-have addition to any O Scale layout!

### Features:

- Separately applied roof walks, ladder, brake wheel & brake lines
- Accurate painting & lettering
- See-through roof walks
- Metal couplers and sprung die-cast trucks
- True scale dimensions with accurate details
- Weighted, detailed underframes
- 2-rail cars feature scale wheels and body mounted scale couplers

Atlas Model Railroad Co., Inc. • 378 Florence Ave., Hillside, NJ 07205 • USA • ph: 908-687-0880 • fax: 908-687-8857 / 908-851-2550 • [shop.atlasrr.com](https://shop.atlasrr.com)



# PREMIER CATALOG SPRING 2023- ROLLING STOCK

**GUARANTEED PRE-ORDER DUE DATE:  
WEDNESDAY JUNE 7<sup>TH</sup> 2023**



## ATLAS TRAINMAN® O 50'6" BOX CAR

Product Info: <https://shop.atlasrr.com/d-693-spring-2023-o-scale-catalog.aspx>

**NEW  
PAINT SCHEMES &  
NEW ROAD  
NUMBERS**



Guilford (Maine Central)+



Rock Island+



Warwick Railroad (GATX)+



Union Pacific (BKTY)+



Railbox (Large Logo)



Santa Fe

*+paint scheme accurate for a similar prototype*



# PREMIER CATALOG SPRING 2023- ROLLING STOCK

**GUARANTEED PRE-ORDER DUE DATE:  
WEDNESDAY JUNE 7<sup>TH</sup> 2023**



## ATLAS TRAINMAN® O 50'6" BOX CAR

**Product Info:** <https://shop.atlasrr.com/d-693-spring-2023-o-scale-catalog.aspx>

**ESTIMATED ARRIVAL: 2nd Quarter 2024**

ORDER IN PIECES	3-RAIL ITEM	ROAD NAME	ROAD NUMBER	COLORS	MSRP/ UNIT
<b>NEW PAINT SCHEMES</b>					
	2001135	Guilford (Maine Central)+	20066, 20102	Gray/Orange	\$62.95
	2001136	Rock Island+	536035, 536048	Blue/White/Black	\$62.95
	2001137	Warwick Railroad (GATX)+	1255, 1283	Brown/White	\$62.95
	2001138	Union Pacific (BKTY)	152966, 152972	Brown/White	\$62.95
<b>NEW ROAD NUMBERS</b>					
	2001139	Railbox (Large Logo)	32682, 32745	Yellow/Black	\$62.95
	2001140	Santa Fe	51263, 51270	Brown/White	\$62.95
<b>TOTAL PIECES ORDERED</b>					

**ESTIMATED ARRIVAL: 2nd Quarter 2024**

ORDER IN PIECES	2-RAIL ITEM	ROAD NAME	ROAD NUMBER	COLORS	MSRP/ UNIT
<b>NEW PAINT SCHEMES</b>					
	2001185	Guilford (Maine Central)+	20066, 20102	Gray/Orange	\$65.95
	2001186	Rock Island+	536035, 536048	Blue/White/Black	\$65.95
	2001187	Warwick Railroad (GATX)+	1255, 1283	Brown/White	\$65.95
	2001188	Union Pacific (BKTY)	152966, 152972	Brown/White	\$65.95
<b>NEW ROAD NUMBERS</b>					
	2001189	Railbox (Large Logo)	32682, 32745	Yellow/Black	\$65.95
	2001190	Santa Fe	51263, 51270	Brown/White	\$65.95
<b>TOTAL PIECES ORDERED</b>					

*+paint scheme accurate for a similar prototype*

In 1974, ACF® built the first box car for Railbox, a subsidiary of the Trailer Train Company. They went on to produce 5,400 50' cars over the next six years, receiving large orders from Class I railroads, shortlines and box car leasing companies. This ATLAS O TRAINMAN® box car is a stunning replica, designed to enhance your layout and provide many hours of reliable operation.

**Features:**

- Prototypical non-terminating corrugated ends
- Diagonal paneled roof
- Single 10' YSD design sliding door
- Weighted, detailed underframes
- Separately-applied end ladders, brake wheels & end platforms
- True scale dimensions with accurate details
- Die-cast roller bearing trucks with rotating bearing caps
- Die-cast couplers
- Accurate painting and lettering
- 2-Rail cars feature scale wheels and body mounted scale couplers
- Minimum diameter curve: 0-31 (3-Rail)
- Minimum radius curve: 24" (2-Rail)



# PREMIER CATALOG SPRING 2023 - TRACK & ACCESSORIES

**GUARANTEED PRE-ORDER DUE DATE:  
WEDNESDAY JUNE 7<sup>TH</sup> 2023**



## ATLAS SANDING TOWER WITH RAILROAD LOGOS

**NEW  
ATLAS O  
ACCESSORY**

Product Info: <https://shop.atlasrr.com/d-693-spring-2023-o-scale-catalog.aspx>

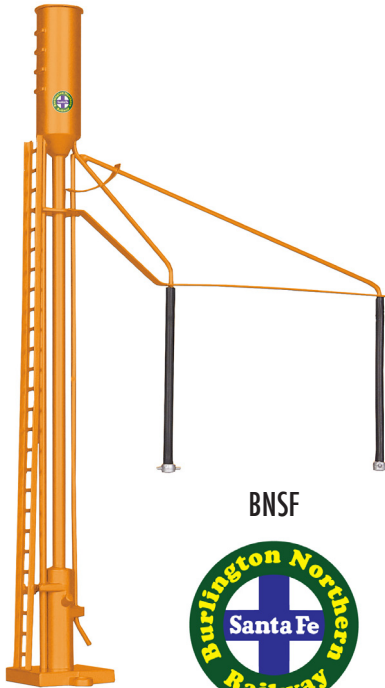

BNSF

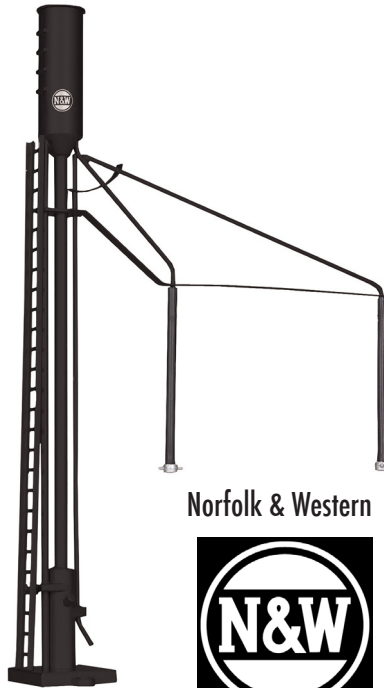

Norfolk & Western



Pennsylvania

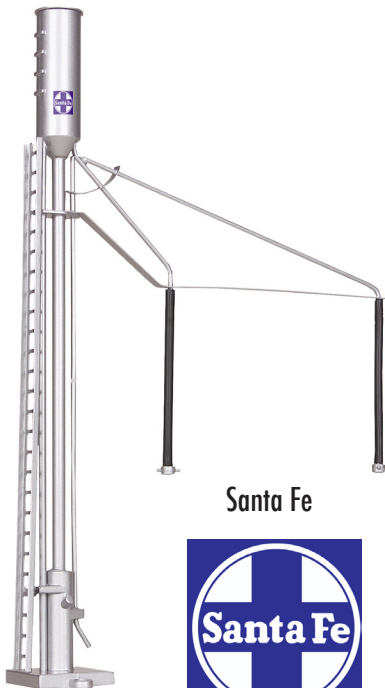

Santa Fe

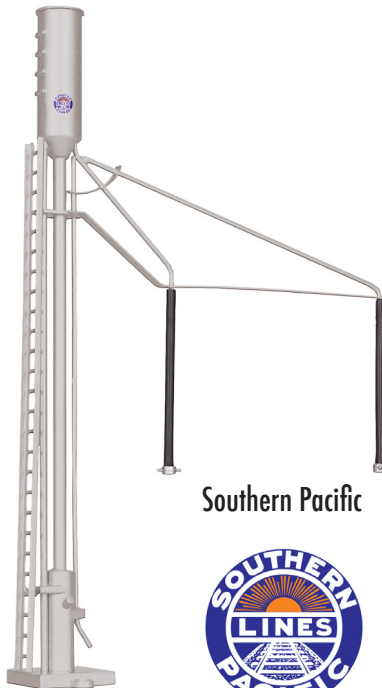

Southern Pacific

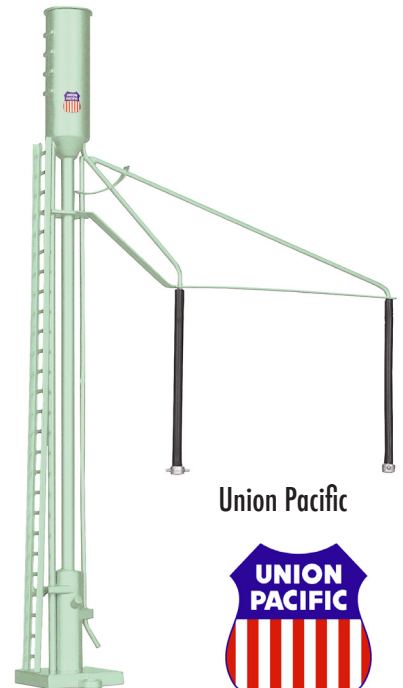

Union Pacific







# PREMIER CATALOG SPRING 2023 - TRACK & ACCESSORIES

**GUARANTEED PRE-ORDER DUE DATE:  
WEDNESDAY JUNE 7<sup>TH</sup> 2023**



## ATLAS SANDING TOWER WITH RAILROAD LOGOS

Product Info: <https://shop.atlasrr.com/d-693-spring-2023-o-scale-catalog.aspx>

**ESTIMATED ARRIVAL: 2nd Quarter 2024**

ORDER IN PIECES	ITEM	ROAD NAME	COLORS	MSRP/ UNIT
<b>NEW PAINT SCHEMES</b>				
	66921	Unlettered (Silver)	Silver	\$59.95
	66922	Unlettered (Black)	Black	\$59.95
	66923	BNSF	Orange	\$59.95
	66924	Norfolk & Western	Black	\$59.95
	66925	Pennsylvania	Black	\$59.95
	66926	Santa Fe	Silver	\$59.95
	66927	Southern Pacific	Gray	\$59.95
	66928	Union Pacific	MOW Green	\$59.95
		<b>TOTAL PIECES ORDERED</b>		

This all-metal O Scale trackside accessory is a great addition for any model railroad featuring steam or diesel motive power pulling long strings of cars. While the accessory doesn't operate, real-life locomotives needed added tractive effort to tackle grades or slippery track brought on by weather conditions.

Locomotives sprayed sand down onto the rails directly in front of the drive wheels. The gritty texture provided increased traction and the sanding towers were conveniently located in areas where traction problems occurred and were just as important as the coal and water towers found throughout the railroads' lines during the steam era.

**Features:**

- All-Metal Construction
- Fully Assembled
- Fully Painted

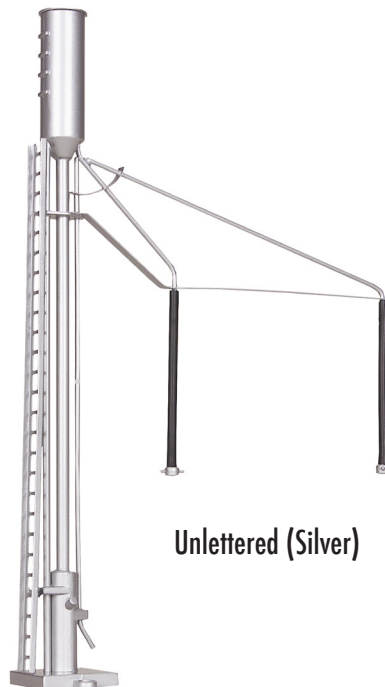

Unlettered (Silver)

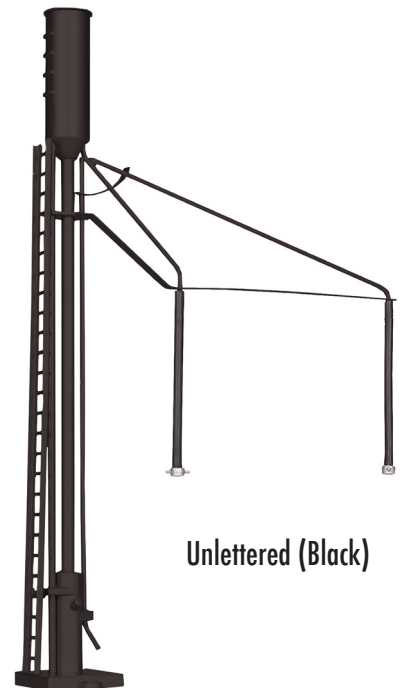

Unlettered (Black)



**ATLAS O TURNTABLE**

**AVAILABLE FROM YOUR LOCAL HOBBY SHOP OR SHOP.ATLASRR.COM**

**Product Info:** <https://shop.atlasrr.com/p-53322-o-scale-turntable.aspx>

**O TURNTABLE** - In the steam era, many railroads used turntables to turn locomotives for their next journey. Railroads still use turntables to assist in the maintenance of diesel locomotives and rolling stock. Based on a Santa Fe prototype, Atlas O has realistically duplicated its above ground details, so adding a working turntable has never been simpler. What's more, everything is included for easy tabletop installation.



**FEATURES:**

- New - larger and more powerful motor
- New - flat cogged anti-slip belt
- New - deck support with more roller bearings for greater support of heavier locomotives
- New - redesigned metal contacts to power the rotating track
- Drive assembly is hidden under the utility shed
- Table diameter: 24"
- Proven Geneva-gearing for positive indexing
- Can be used for both 3 rail and 2 rail operation
- Will run on AC or DC power
- Compatible w/ TMCC & DCS (using TMCC or DCS accessory interface)
- Compatible with DCC (using a stationary decoder)
- Molded in appropriate colors
- Complete hook-up instructions
- Easy tabletop installation
- Motor Drive included in box for smooth and easy operation

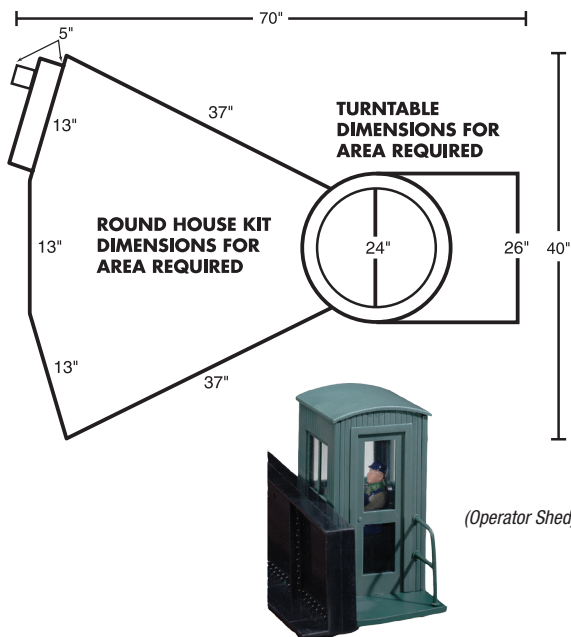

**Item #6999**

**Atlas O Turntable - Available Now!**



**ATLAS O SIGNAL SYSTEM**  
**AVAILABLE FROM YOUR LOCAL HOBBY SHOP OR SHOP.ATLASRR.COM**

**Product Info:** <https://shop.atlasrr.com/c-1026-o-signal-system.aspx>

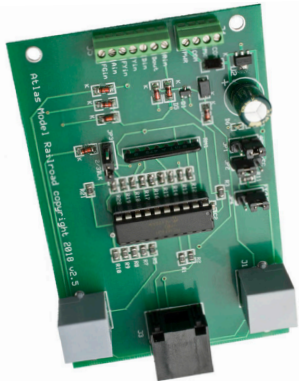

Item #70 000 046  
Universal Signal Control Board



Item #70 000 050 - Signal Attachment Cable



Item #70 000 056 - O Signal  
Attachment Cable Compatibility Connector



Item #70 000 141 - O Scale Starter Set  
contains: 1 - 70 000 068 O Type G Signal  
1 - 70 000 046 Universal Signal Control Board  
1 - 70 000 050 Signal Attachment Cable  
1 - Quick Start Guide

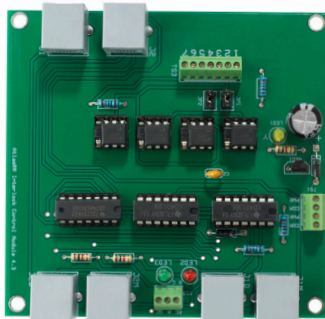

Item #70 000 047 - Interlock Control Module



Item #70 000 060 - Universal Cable Connector



Item #70 000 064 - O Signal, Color Position Light,  
Single Head



Item #70 000 066- O Signal, PRR Position Light,  
Single Head



Item #70 000 068 - O Signal, Type G, Single Head



Item #70 000 070 - O Signal, Type SA, Single Head



ATLAS O SCALE TRACK & ACCESSORIES  
AVAILABLE FROM YOUR LOCAL HOBBY SHOP OR SHOP.ATLASRR.COM

Product Info: <https://shop.atlasrr.com>

Atlas is proud to offer a wide variety of track in both 2- and 3-Rail. Our track is time-tested and modeler approved and is crafted to be the MVP of your layout.

**Modeled for Realism:** The scale-sized plastic ties have a realistic wood grain, the tie plates have spikes, the rail joiners have authentic bolt detail and the center rail is blackened.

**Versatility:** Every track piece has been specially engineered to fit precisely together in an infinite variety of combinations without the need for custom cutting and fitting.

**Performance:** We chose a SOLID nickel silver T-rail for extra stability and superior electrical conductivity. In addition, the wide, flat surface of the rails provides far greater wheel/rail contact and better traction than tubular track. What's more, solid rails absorb sound better than tubular track so you can enjoy the sounds of your locomotive.

**3-RAIL FEATURES:**

- SOLID nickel silver rail for realistic shape, sounds and rust prevention
- Super joiners for tight fit and superior electrical connection
- Large and growing list of track: 10 different diameters (O-27- O-108), 16 different switches, 6 crossings, all the straight pieces you could ever want, flex track and more!
- Geometrically exact layout construction
- UV compatible: great for both indoor and outdoor use



Item #6094 - Track Screws

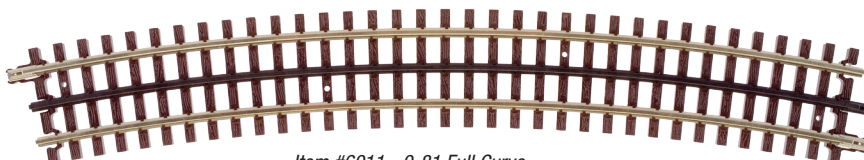

Item #6011 - 0-81 Full Curve



**2-RAIL FEATURES:**

- Code 148 Solid Nickel Silver Rail
- American prototype ties and tie spacing with correct spike, and tie plate and bolt details
- Dark brown tie strip
- Turnouts feature highly detailed metal insulated frogs and points
- Metal frog can be powered if desired
- UV compatible: great for both indoor and outdoor use

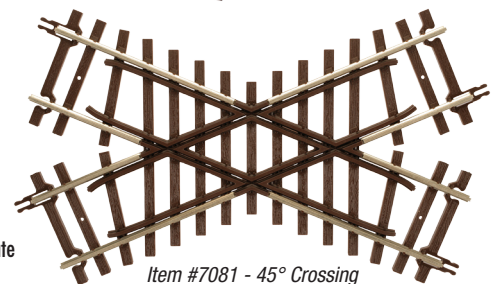

Item #7081 - 45° Crossing



Item #7090  
Terminal Joiners (1 pair)

Item #7056 - 2-Rail  
40" Flex-Track® with  
Simulated Wood Ties



Item #7050 - 10" Straight



**ATLAS O SCALE TRACK & ACCESSORIES**  
**AVAILABLE FROM YOUR LOCAL HOBBY SHOP OR SHOP.ATLASRR.COM**

**Product Info:** <https://shop.atlasrr.com>

*Atlas also offers a growing selection of structures, layout accessories and signals for layouts of all sizes. No matter the era or level of detail you choose for your layout, you can be sure that Atlas has the perfect accessories to complete your model empire!*



Item #6907 - Jack's Lumber Company Kit



Item #66904 - Oil Pump/Black  
Available in additional colors and styles including the New Red Bird and Zebra styles! (item #s 66905-66909)



Item #6920 - Single Track Pratt Truss Bridge Kit (3-Rail)



Item #6948 - Operating Crossing Gate - Black/White  
Item #6949 - Operating Crossing Gate - Red/White



Item #66915 - Single Traffic Signal



Item #66912 - Wilson's Gas n Go Structure Kit



Item #4002027 - Coolers with Ice (2/pkg.)  
Item #4002001 - Fire Hydrants (3/pkg.)

Additional styles of detail parts & accessories are also available.



Item #6916 Steel Water Tower Kit



Item #6917 Wheeler's Auto Dealer Kit



Item #6909 Fairview Farm Dairy Kit



**ATLAS O SCALE TRACK & ACCESSORIES**  
**AVAILABLE FROM YOUR LOCAL HOBBY SHOP OR SHOP.ATLASRR.COM**

Product Info: <https://shop.atlasrr.com>

ORDER QTY.	ITEM #	DESCRIPTION	MSRP
<b>O SCALE LAYOUT BOOKS</b>			
	0104-4	Atlas All Scales Track Catalog	\$4.95
<b>O SCALE 3-RAIL CURVED TRACK</b>			
	6011	0-81 Full Curve (16 pcs to circle)	\$16.50
<b>O SCALE 3-RAIL TRACK ACCESSORIES</b>			
	6094	Track Screws (48 pcs/Bag)	\$6.50
<b>O SCALE 3-RAIL BRIDGES</b>			
	6920	Single Track Pratt Truss Bridge Kit	\$259.95
<b>O SCALE 2-RAIL TRACK - BROWN TIES, NICKEL SILVER RAIL</b>			
<b>STRAIGHT TRACK</b>			
	7050	10" Straight	\$8.75
	7056	40" Flex Track with Simulated Wood Ties	\$26.25
<b>CUSTOM SUPREME CROSSINGS</b>			
	7081	45° Crossing	\$30.75
<b>O SCALE 2-RAIL TRACK ACCESSORIES</b>			
	7090	Terminal Joiners (1 pr./bag)	\$7.75
<b>O SCALE LAYOUT ACCESSORIES</b>			
	6999	Turntable (for 3-rail and 2-rail operation)	\$349.95
<b>O SCALE HILLSIDE STRUCTURES</b>			
	6909	Fairview Farm Dairy Kit	\$77.95
	6916	Steel Water Tower Kit	\$48.95
	6917	Wheeler's Auto Dealers	\$72.95
	66904	Operating Oil Pump - Black	\$109.95
	66912	"Wilson's Gas & Go" Service Station Kit - NEW	\$72.50
	6948	Operating Crossing Gate (Black & White)	\$72.95
	6949	Operating Crossing Gate (Red & White)	\$72.95
<b>O SCALE PREMIER LAYOUT ACCESSORIES</b>			
	66915	Single Traffic Signal (2 pcs plus controller)	\$47.95
<b>O SCALE 3D PRINTED DETAIL PARTS &amp; ACCESSORIES</b>			
	4002001	O SCALE 3D Fire Hydrants (3 per pkg.)	\$10.50
	4002027	O SCALE 3D Cooler with Ice (2 per pkg.)	\$12.95
<b>UNIVERSAL SIGNAL SYSTEM</b>			
	70 000 046	Universal Signal Control Board	\$31.95
	70 000 047	Interlock Control Module	\$37.95
	70 000 050	Signal Attachment Cable	\$9.95
	70 000 051	Signal Attachment Cable, dual 4-pin harness DIY set	\$4.50
	70 000 052	Signal Extension Cable, short (6')	\$5.50
	70 000 053	Signal Extension Cable, medium (12')	\$9.95
	70 000 054	Signal Extension Cable, long (20')	\$14.50
	70 000 057	SCB Interconnect Cable, short	\$6.50



**ATLAS O SCALE TRACK & ACCESSORIES**  
**AVAILABLE FROM YOUR LOCAL HOBBY SHOP OR SHOP.ATLASRR.COM**

Product Info: <https://shop.atlasrr.com>

ORDER QTY.	ITEM #	DESCRIPTION	MSRP
UNIVERSAL SIGNAL SYSTEM CONTINUED			
	70 000 058	SCB Interconnect Cable, medium	\$11.95
	70 000 059	SCB Interconnect Cable, long	\$16.50
	70 000 060	SCB Universal Cable Connector	\$4.50
O SCALE SIGNALS			
	70 000 141	O Scale Starter Set (incl. 1- 70 000 068, 1- 70 000 046, 1- 70 000 050)	\$99.95
	70 000 056	O Signal Attachment Cable Compatibility Connector	\$6.25
	70 000 064	O Signal, Color Position Light, Single Head	\$72.95
	70 000 066	O Signal, PRR Position Light, Single Head	\$72.95
	70 000 068	O Signal, Type G, Single Head	\$67.95
	70 000 070	O Signal, Type SA, Single Head	\$67.95
	70 000 072	O Signal, Dwarf / Turnout Indicator	\$13.50

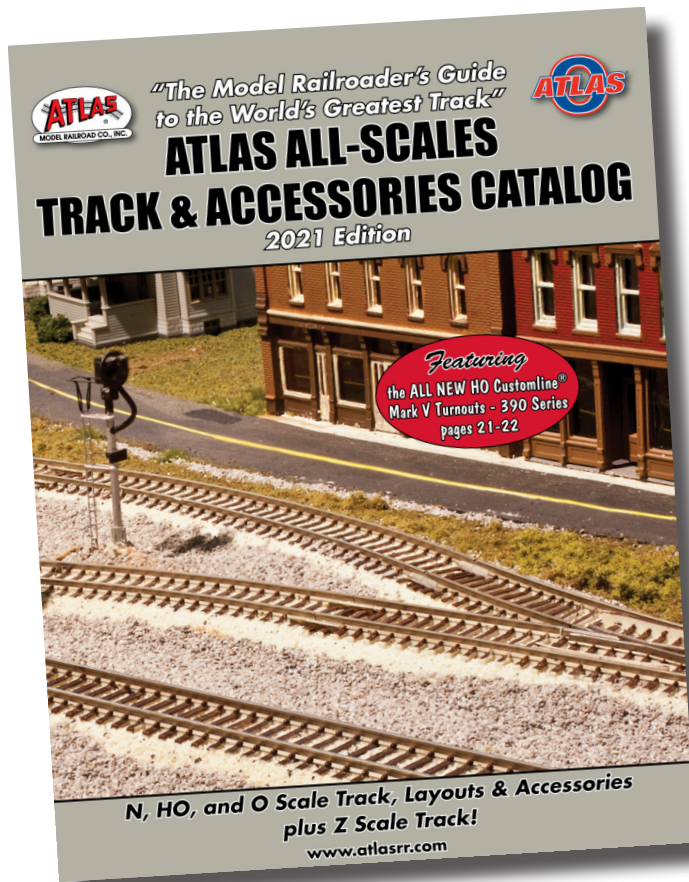

**ALL OF ATLAS' O SCALE TRACK,  
STRUCTURES & ACCESSORIES CAN  
BE FOUND IN OUR COMPREHENSIVE  
148 PAGE  
'ATLAS ALL SCALES TRACK &  
ACCESSORIES CATALOG'  
CONTACT YOUR LOCAL HOBBY SHOP  
TO ORDER YOUR COPY TODAY!**

Item #0104-4  
Atlas Track Catalog



## 2023 GOLDEN SPIKE CLUB MEMBERSHIP

<https://shop.atlasrr.com/c-1000-ogsc.aspx>

***Become a Member of Atlas O's Golden Spike Club! Don't Delay  
Join Today – Memberships for 2023 are Available Now!***

***Sign-up online or download your application today at: [shop.atlasrr.com/c-100-ogscx.htm](https://shop.atlasrr.com/c-100-ogscx.htm) For more information on membership, or to join, please contact Patricia Kimble, Golden Spike Club Coordinator at 908-687-0880 ext. 7122, or via email [pkimble@atlasrr.com](mailto:pkimble@atlasrr.com)***

### THE BENEFITS

Club benefits for all members in all levels include:

- **Laminated membership card:** with member's name and number: The membership card features artwork that changes from year to year, highlighting the annual club car on its front.
- **Club lapel pin (New members only):** Wear it and let your friends know that you're a member of the Atlas Golden Spike Club with this pin, handsomely crafted and sporting the colorful logo.
- **Opportunity to Purchase "Members Only" Annual Club Car:** As a club member you will have the option to purchase exclusive members only annual club car(s).
- **Discounted Pricing on Club Offers:** As a club member, you will have the opportunity to purchase premium Atlas products at special Golden Spike Club pricing.
- **Insider Club News:** Get the inside scoop on the latest club offerings and the stories behind them, as well as other special offers and more mailed/e-mailed directly to you!
- **FREE Ground Shipping:** For any regular on-line orders shipped within the continental US.

## 2023 ANNUAL CLUB CARS ATLAS O PREMIER 2-BAY OFFSET HOPPER

\*available with deluxe memberships

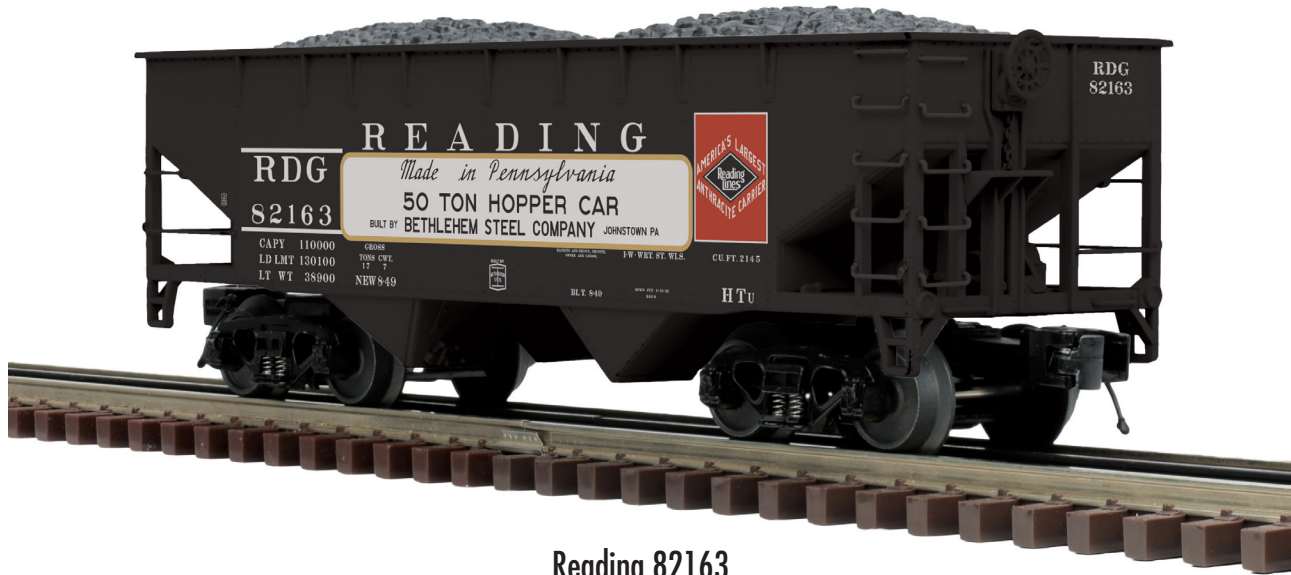

Reading 82163

Keep an eye out for GSC 2023 Special Offers! Information coming soon!

Atlas Model Railroad Co., Inc. • 378 Florence Ave., Hillside, NJ 07205 • USA • ph: 908-687-0880 • fax: 908-687-8857 / 908-851-2550 • [shop.atlasrr.com](https://shop.atlasrr.com)